

DK60-C02-9 9 watts



Référence	Puissance	Couleur Température	Flux Lumineux
DK60-C01-9-2700	9 w	2700K	850 lm
DK60-C01-9-3000	9 w	3000K	890 lm
DK60-C01-9-4000	9 w	4000K	950 lm

Caractéristiques Luminaire

Taille de Coupe	Taille Luminaire	IRC	IP	UGR	RG	MacAdam	Angle de Diffusion	Variable	Orientable	Diode	Durée de Vie	Garantie
ø60 mm	65 x 65 x 71 mm	97	44	16	0	2	24° - 40° - 60°	oui	non	Citizen	50 000 h	5 ans

Caractéristiques Alimentation

Tension d'alimentation	Fréquence	Tension de Sortie	Température de Fonctionnement
200 - 250V	50 - 60 Hz	250mA 34Vdc	de -20 ° à +45°

Options

Variation 1-10V
DALI

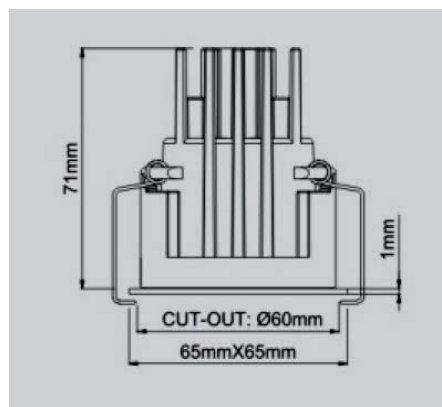

Certifications

CE - RoHS - 960°

DK60-C02-9 9 watts

